

Drainage Pipes

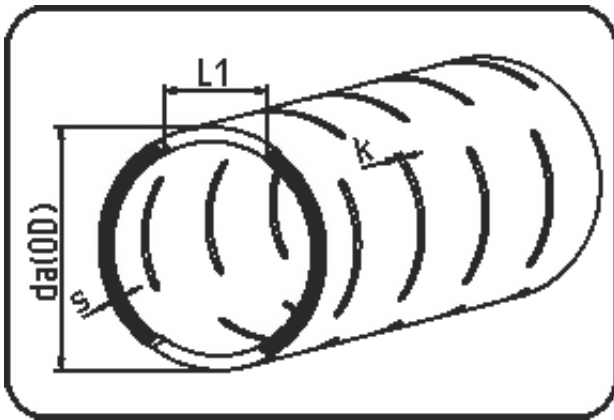

Code: 733

- Drainage Pipe 12m
- fully slotted
- extruded+slotted
- PE 100 black

Not available from stock - delivery time on request.

Dimension	Code	Detail	Weight
225	25.733.0225.11	225X20,5 SDR11 ISO S-5	13.30

	Unit	Nominale	Tol+	Tol-
da(OD)	mm	225	0.40	0.00
L1	mm	67	4.50	4.50
s	mm	20,5	0.70	0.00
K	mm	3/4/6/8/10	10.00	8.50