

Saddles

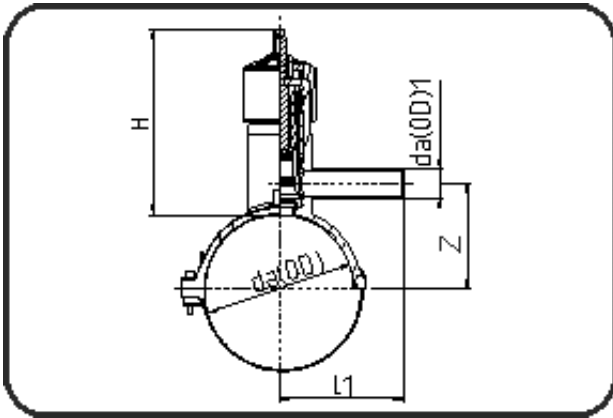

Code: 70.079

- **Pressure Tapping Valve**
- brass-valve+integrated cutter
- W/P-TW
- injection moulded
- **Electro-fusion**
- **PE 100-RC black**

For operating the pressure tapping valve an installation kit is required.

Dimension	Code	Detail	Weight
125/50	70.079.1250.11	125/50 SDR 17 - 11 PN16	2.52

	Unit	Nominale	Tol+	Tol-
da(OD)	mm	125	0.50	0.00
L1	mm	161	1.00	1.00
h	mm	203	0.60	0.00
da(OD1)	mm	50	0.40	0.00
z	mm	95,9	0.00	0.00