

Sweep Bends

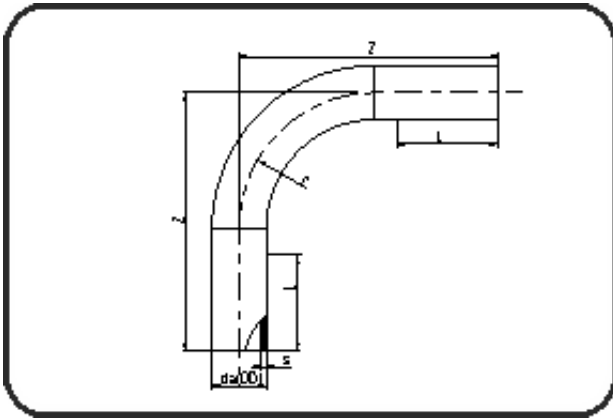

Code: 399

- Sweep Bend 90°
- radius 1.5 x OD
- formed out of pipe
- **Butt + E-socket-welding**
- **PE 100-RC black**

Dimension	Code	Detail	Weight
125	70.399.0125.17	125 SDR17 ISO S-8 10 bar	2.07

	Unit	Nominale	Tol+	Tol-
da(OD)	mm	125	0.00	0.00
L	mm	150	0.00	0.00
r	mm	188	0.00	0.00
s	mm	7,4	0.00	0.00
z	mm	470	75.00	75.00