

Fittings with short Spigot

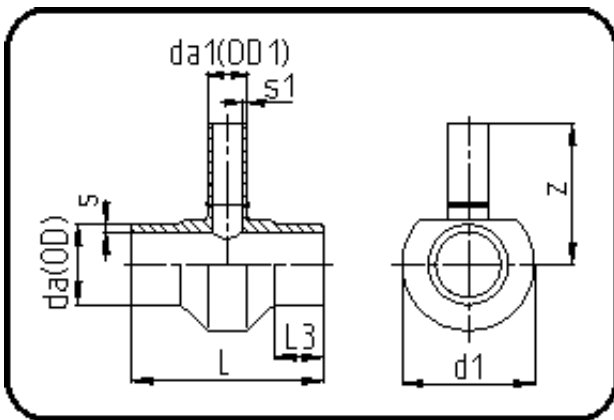

Code: 307

- Tee reduced
- short spigot
- machined
- **Butt-welding**
- PE 100-RC black

Dimension	Code	Detail	Weight
355/110	70.307.3511.09	355/110 SDR9 ISO S-4	17.33

	Unit	Nominale	Tol+	Tol-
da(OD)	mm	355	3.20	0.00
L	mm	310	3.00	3.00
L3	mm	75	1.50	1.50
s	mm	39,7	4.10	0.00
d1	mm	420	1.50	1.50
s1	mm	12,3	1.40	0.00
da(OD1)	mm	110	1.00	0.00
z	mm	302,5	15.00	15.00