

Elongated Fittings

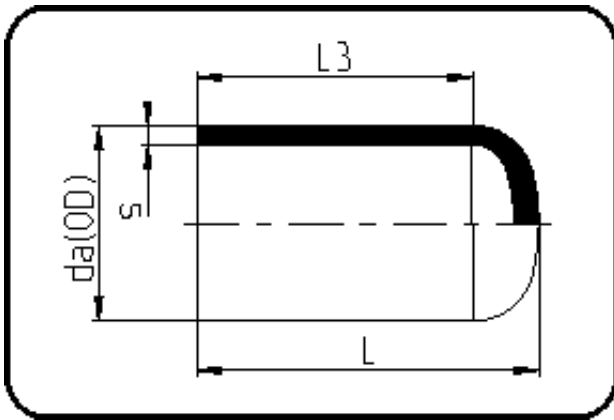

Code: 064

- End Cap
- long spigot
- W/P-TW
- injection moulded+chamfered
- **Butt + E-socket-welding**
- PE 100-RC black

Dimension	Code	Detail	Weight
75	70.064.0075.09	75X8,4 SDR9 PN20	0.17

	Unit	Nominale	Tol+	Tol-
da(OD)	mm	75	0.00	0.00
L	mm	94	1.50	1.50
L3	mm	75	1.50	1.50
s	mm	8,4	0.00	0.00