

Fittings with short Spigot

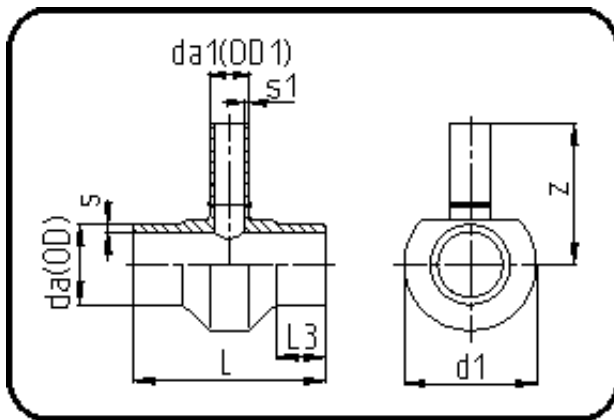

Code: 307

- Tee reduced
- short spigot
- machined
- **Butt-welding**
- PE 100-RC black

Dimension	Code	Detail	Weight
400/225	70.307.4022.09	400/225 SDR9 ISO S-4	39.00

	Unit	Nominale	Tol+	Tol-
da(OD)	mm	400	3.60	0.00
L	mm	425	4.50	4.50
L3	mm	75	1.50	1.50
s	mm	44,7	4.60	0.00
d1	mm	504	1.50	1.50
s1	mm	25,2	2.70	0.00
da(OD1)	mm	225	2.10	0.00
z	mm	375	22.50	22.50