

SURELINE II Pipes

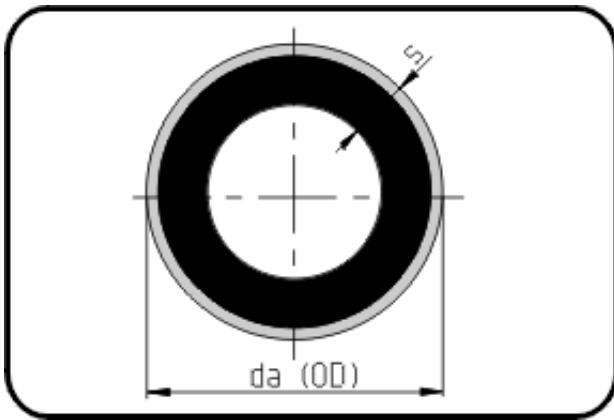

Code: 712.2

- Pipe black 12m
- with green signal layer
- extruded
- PE 100-RC SURELINE II

From dim. 250 not available from stock - delivery time on request.

Dimension	Code	Detail	Weight
315	70.712.2315.17	315X18,7 SDR17 ISO S-8	17.60

	Unit	Nominale	Tol+	Tol-
da(OD)	mm	315	1.90	0.00
s	mm	18,7	2.00	0.00