

Fittings for Socket Welding

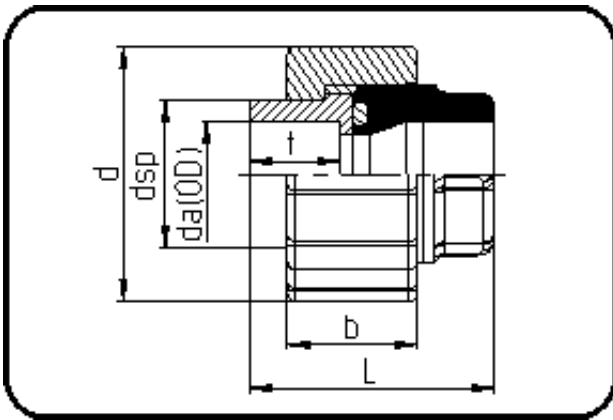

Code: 024.11

- Union Type 24
- FPM-sealing
- injection moulded
- **Socket-welding**
- PE 100-RC black

Dimension	Code	Detail	Weight
63	70.024.1163.07	63 - MOP 10 bar	0.30

	Unit	Nominale	Tol+	Tol-
da(OD)	mm	63	0.00	0.00
L	mm	79	3.00	3.00
b	mm	39	1.50	1.50
dsp	mm	73,6	1.00	1.00
d	mm	109	1.50	1.50
t	mm	29	1.50	1.50