

## Segmented Fittings

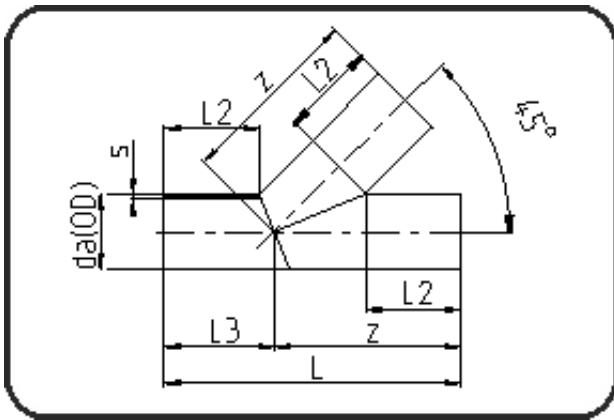

Code: 325

- Tee 45°
- segmented
- derating factor 0.6
- **Butt + E-socket-welding**
- **PE 100-RC black**

Dimension	Code	Detail	Weight
450	70.325.0450.17	450X26,7 SDR17 ISO S-8	79.80

	Unit	Nominale	Tol+	Tol-
da(OD)	mm	450	0.00	0.00
L	mm	1.336	30.00	30.00
L3	mm	443	0.00	0.00
L2	mm	350	0.00	0.00
s	mm	26,7	0.00	0.00
z	mm	893	30.00	30.00