

Saddles

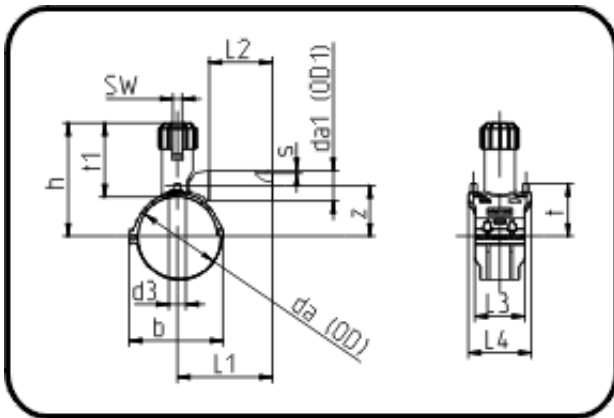

Code: 278

- Tapping Saddle with screw cap
- gastight-bottom part screwable
- injection moulded
- **Electro-fusion**
- **PE 100-RC black**

Dimension	Code	Detail	Weight
90/25	70.278.9025.11	90/25 SDR 17 - 11	0.74

	Unit	Nominale	Tol+	Tol-
s	mm	3	0.40	0.00
t	mm	73	0.00	0.00
t1	mm	152	0.00	0.00
z	mm	67	1.00	1.00
da(OD)	mm	90	0.00	0.00
L1	mm	125	2.00	2.00
SW	mm	17	0.00	0.00
L3	mm	103	1.00	1.00
L2	mm	89	1.00	1.00
L4	mm	130	1.50	1.50
b	mm	128	0.00	0.00
d3	mm	32	0.00	0.00
h	mm	196,5	0.00	0.00
da(OD1)	mm	25	0.30	0.00