

SURELINE II Pipes

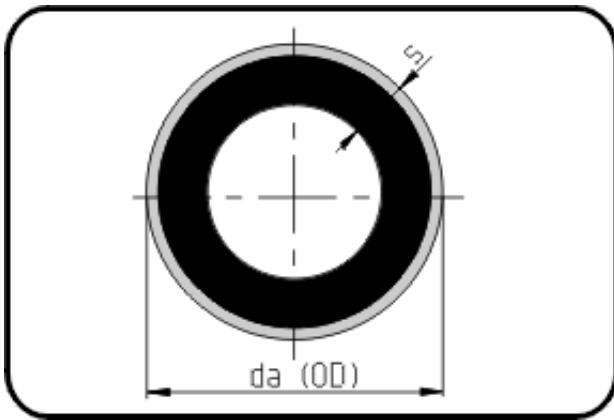

Code: 712.2

- Pipe black 12m
- with green signal layer
- extruded
- **PE 100-RC SURELINE II**

From dim. 250 not available from stock - delivery time on request.

Dimension	Code	Detail	Weight
75	70.712.2075.17	75X4,5 SDR17 ISO S-8	1.03

	Unit	Nominale	Tol+	Tol-
da(OD)	mm	75	0.50	0.00
s	mm	4,5	0.60	0.00