

## Fittings with short Spigot

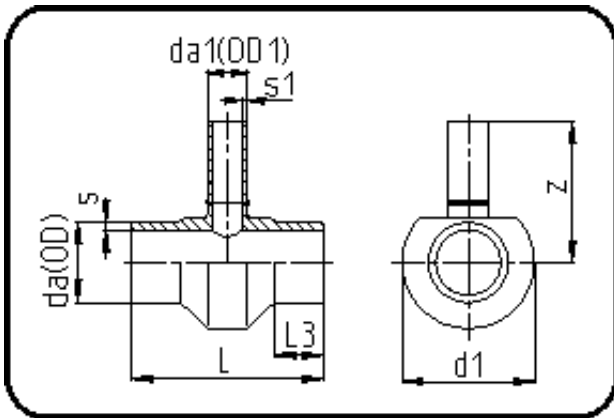

Code: 307

- Tee reduced
- short spigot
- machined
- **Butt-welding**
- **PE 100-RC black**

Dimension	Code	Detail	Weight
200/125	70.307.2012.09	200/125 SDR9 ISO S-4	9.00

	Unit	Nominale	Tol+	Tol-
da(OD)	mm	200	1.80	0.00
L	mm	275	3.00	3.00
L3	mm	50	1.50	1.50
s	mm	22,4	2.40	0.00
d1	mm	280	1.50	1.50
s1	mm	14	1.50	0.00
da(OD1)	mm	125	1.20	0.00
z	mm	225	15.00	15.00