

Fittings with short Spigot

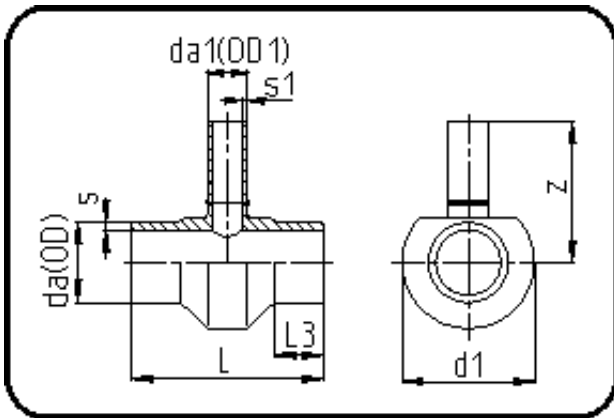

Code: 307

- Tee reduced
- short spigot
- machined
- **Butt-welding**
- **PE 100-RC black**

Dimension	Code	Detail	Weight
400/200	70.307.4020.09	400/200 SDR9 ISO S-4	32.25

	Unit	Nominale	Tol+	Tol-
da(OD)	mm	400	3.60	0.00
L	mm	400	3.00	3.00
L3	mm	75	1.50	1.50
s	mm	44,7	4.60	0.00
d1	mm	493	1.50	1.50
s1	mm	22,4	2.40	0.00
da(OD1)	mm	200	1.80	0.00
z	mm	375	18.00	18.00