

Electro Fusion Fittings

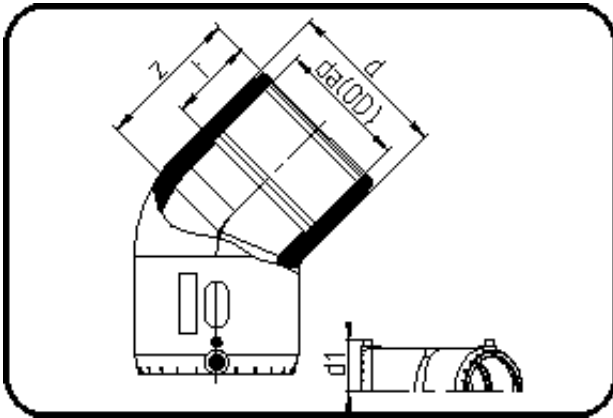

Code: 170

- **E-Elbow 45°**
- MOP water 16bar/gas 10bar
- W/P-TW
- injection moulded
- **Electro-fusion**
- **PE 100-RC black**

Dimension	Code	Detail	Weight
110	70.170.0110.11	110 SDR 17-11	1.44

	Unit	Nominale	Tol+	Tol-
da(OD)	mm	110	0.00	0.00
d	mm	140	1.50	1.50
d1	mm	82,5	1.50	1.50
t	mm	71	2.25	2.25
z	mm	124	2.25	2.25