

Segmented Fittings

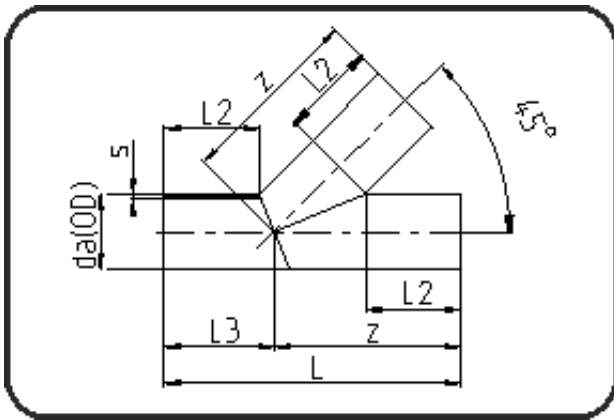

Code: 325

- Tee 45°
- segmented
- derating factor 0.6
- **Butt + E-socket-welding**
- **PE 100-RC black**

Dimension	Code	Detail	Weight
280	70.325.0280.17	280X16,6 SDR17 ISO S-8	20.10

	Unit	Nominale	Tol+	Tol-
da(OD)	mm	280	0.00	0.00
L	mm	996	15.00	15.00
L3	mm	358	0.00	0.00
L2	mm	300	0.00	0.00
s	mm	16,6	0.00	0.00
z	mm	638	15.00	15.00