

Electro Fusion Fittings

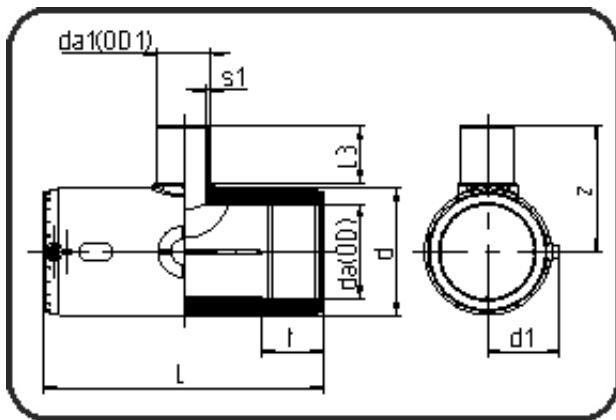

Code: 175

- E-Tee reduced
- MOP water 16bar/gas 10bar
- W/P-TW
- injection moulded
- **Electro-fusion**
- **PE 100-RC black**

Dimension	Code	Detail	Weight
160/63	70.175.1663.11	160/63 SDR 17-11	5.50

	Unit	Nominale	Tol+	Tol-
da(OD)	mm	160	1.00	0.00
L	mm	370,5	6.00	0.00
L3	mm	66	2.25	2.25
d	mm	211,5	1.50	1.50
d1	mm	110,5	1.50	1.50
t	mm	85	3.00	3.00
s1	mm	5,8	0.70	0.00
da(OD1)	mm	63	0.40	0.00
z	mm	180	2.25	2.25