

SURELINE II Pipes

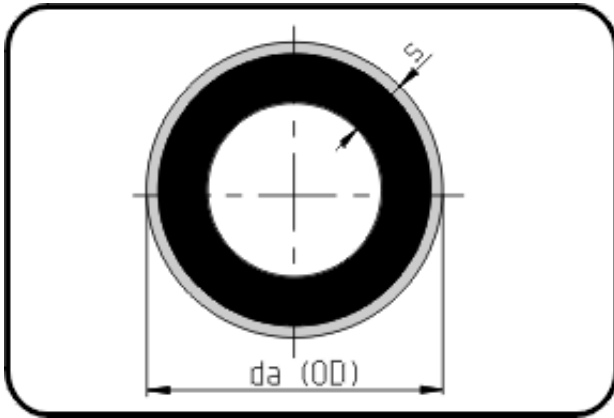

Code: 712.2

- Pipe black 12m
- with green signal layer
- extruded
- **PE 100-RC SURELINE II**

From dim. 250 not available from stock - delivery time on request.

Dimension	Code	Detail	Weight
90	70.712.2090.11	90X8,2 SDR11 ISO S-5	2.14

	Unit	Nominale	Tol+	Tol-
da(OD)	mm	90	0.00	0.00
s	mm	8,2	0.70	0.00