

Pipes

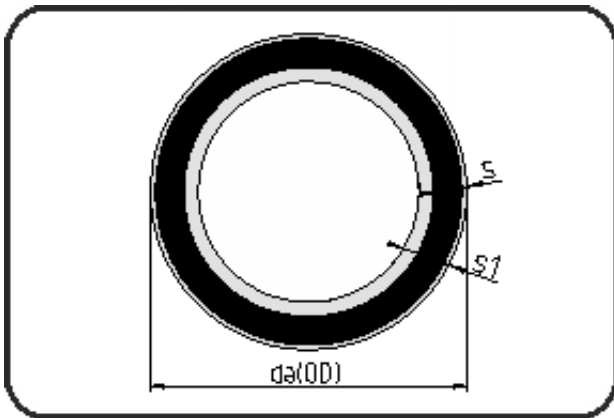

Code: 3M.705

- **Mineline II Pipe 5m**
- white signal-layer and abrasion-layer
- extruded
- **PE-RC Mineline II**

Not available from stock. Fittings on request.

Dimension	Code	Detail	Weight
450	3M.705.0450.11	450x40,9 SDR11 ISO S-5	59.90

	Unit	Nominale	Tol+	Tol-
$da(OD)$	mm	450	2.70	0.00
s	mm	40,9	4.20	0.00
s1	mm	46,9	5.30	0.00