

Fittings with short Spigot

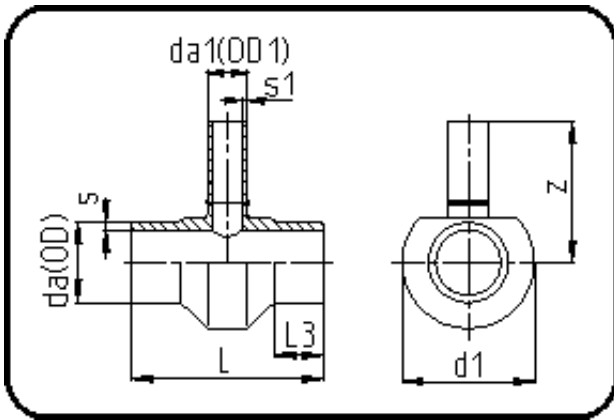

Code: 307

- Tee reduced
- short spigot
- machined
- **Butt-welding**
- **PE 100-RC black**

Dimension	Code	Detail	Weight
180/75	70.307.1875.09	180/75 SDR9 ISO S-4	4.50

	Unit	Nominale	Tol+	Tol-
da(OD)	mm	180	1.70	0.00
L	mm	225	2.00	2.00
L3	mm	50	1.00	1.00
s	mm	20,1	2.20	0.00
d1	mm	242	1.00	1.00
s1	mm	8,4	1.00	0.00
da(OD1)	mm	75	0.70	0.00
z	mm	215	3.00	3.00