

## Elongated Fittings

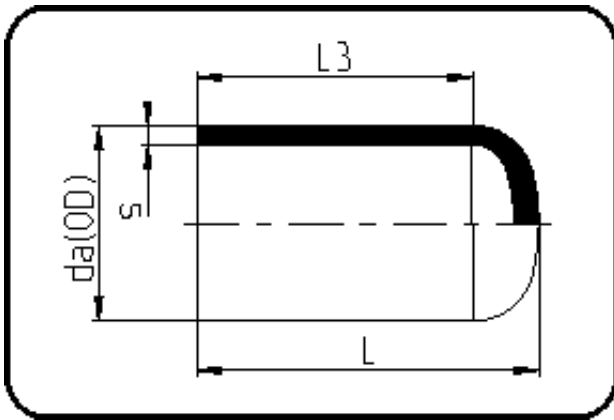

Code: 064

- End Cap
- long spigot
- W/P-TW
- injection moulded
- **Butt + E-socket-welding**
- PE 100-RC black

Dimension	Code	Detail	Weight
315	70.064.0315.11	315X28,6 SDR11 PN16	7.08

	Unit	Nominale	Tol+	Tol-
da(OD)	mm	315	1.90	0.00
L	mm	269	3.00	3.00
L3	mm	167	3.00	3.00
s	mm	28,6	3.00	0.00