

Electro Fusion Fittings

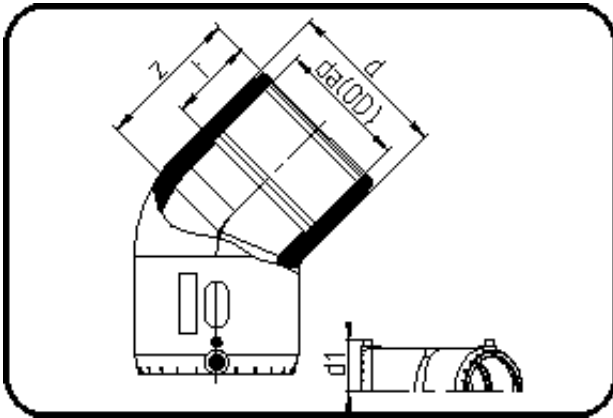

Code: 170

- **E-Elbow 45°**
- MOP water 16bar/gas 10bar
- W/P-TW
- injection moulded
- **Electro-fusion**
- **PE 100-RC black**

Dimension	Code	Detail	Weight
50	70.170.0050.11	50 SDR 17-11	0.20

	Unit	Nominale	Tol+	Tol-
da(OD)	mm	50	0.00	0.00
d	mm	67	0.75	0.75
d1	mm	53	1.50	1.50
t	mm	54	1.50	1.50
z	mm	70	2.25	2.25