

Segmented Fittings

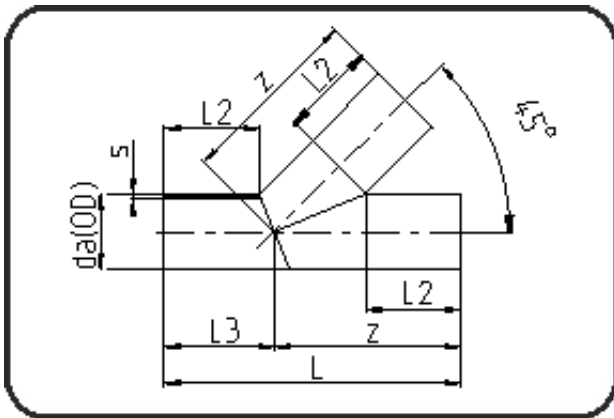

Code: 325

- Tee 45°
- segmented
- derating factor 0.6
- **Butt + E-socket-welding**
- **PE 100-RC black**

Dimension	Code	Detail	Weight
560	70.325.0560.11	560X50,8 SDR11 ISO S-5	206.00

	Unit	Nominale	Tol+	Tol-
da(OD)	mm	560	0.00	0.00
L	mm	1.492	30.00	30.00
L3	mm	466	0.00	0.00
L2	mm	350	0.00	0.00
s	mm	50,8	0.00	0.00
z	mm	1.026	30.00	30.00