

Fittings with short Spigot

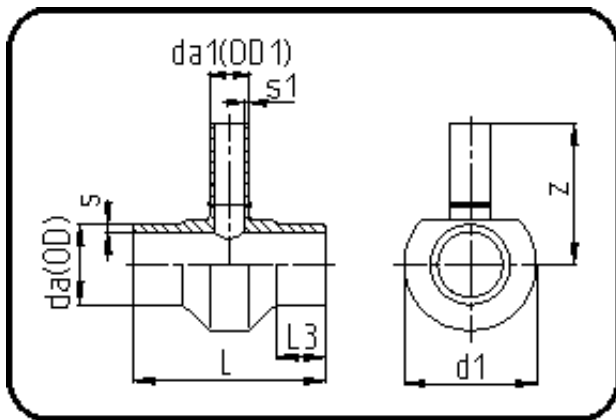

Code: 307

- Tee reduced
- short spigot
- machined
- **Butt-welding**
- **PE 100-RC black**

Dimension	Code	Detail	Weight
180/110	70.307.1811.09	180/110 SDR9 ISO S-4	7.70

	Unit	Nominale	Tol+	Tol-
da(OD)	mm	180	1.70	0.00
L	mm	260	3.00	3.00
L3	mm	50	1.50	1.50
s	mm	20,1	2.20	0.00
d1	mm	255	1.50	1.50
s1	mm	12,3	1.40	0.00
da(OD1)	mm	110	1.00	0.00
z	mm	215	15.00	15.00