

SURELINE II Pipes

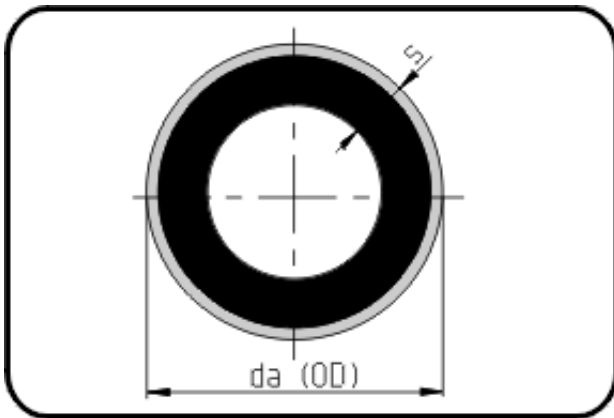

Code: 712.2

- Pipe black 12m
- with green signal layer
- extruded
- PE 100-RC SURELINE II

From dim. 250 not available from stock - delivery time on request.

Dimension	Code	Detail	Weight
280	70.712.2280.17	280X16,6 SDR17 ISO S-8	13.90

	Unit	Nominale	Tol+	Tol-
da(OD)	mm	280	1.70	0.00
s	mm	16,6	1.80	0.00