

Elongated Fittings

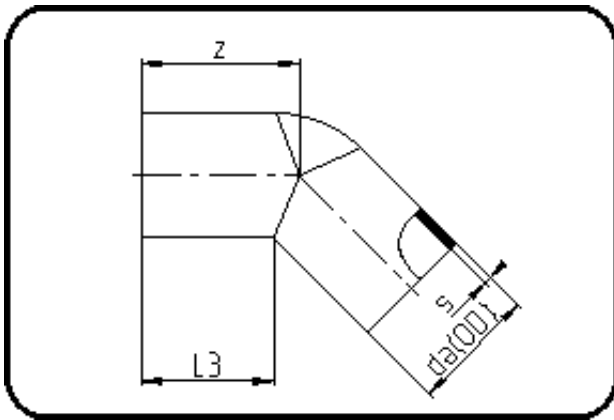

Code: 060

- **Elbow 45°**
- long spigot
- W/P-TW
- injection moulded
- **Butt + E-socket-welding**
- **PE 100-RC black**

Dimension	Code	Detail	Weight
90	70.060.0090.17	90X5,4 SDR17 PN10	0.30

	Unit	Nominale	Tol+	Tol-
da(OD)	mm	90	0.60	0.00
L3	mm	80	1.50	1.50
s	mm	5,4	0.70	0.00
z	mm	101	1.50	1.50