

Fittings with short Spigot

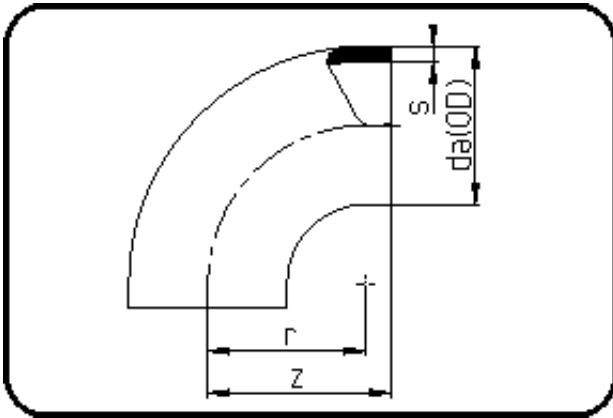

Code: 001

- Bend 90°
- short spigot
- injection moulded
- **Butt-welding**
- PE 100-RC black

Dimension	Code	Detail	Weight
225	70.001.0225.33	225X6,9 SDR33 ISO S-16	2.00

	Unit	Nominale	Tol+	Tol-
da(OD)	mm	225	2.10	0.00
r	mm	225	0.00	0.00
s	mm	6,9	0.80	0.00
z	mm	245	4.50	4.50