

Sweep Bends

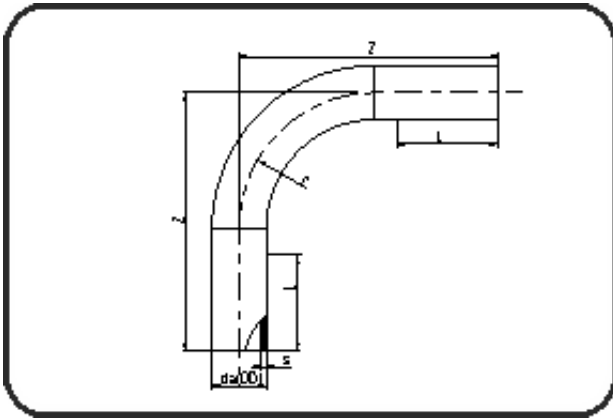

Code: 399

- Sweep Bend 90°
- radius 1.5 x OD
- formed out of pipe
- **Butt + E-socket-welding**
- **PE 100-RC black**

Dimension	Code	Detail	Weight
140	70.399.0140.11	140 SDR11 ISO S-5 16 bar	4.76

	Unit	Nominale	Tol+	Tol-
da(OD)	mm	140	0.00	0.00
L	mm	150	0.00	0.00
r	mm	210	0.00	0.00
s	mm	12,7	0.00	0.00
z	mm	520	75.00	75.00