

Fittings with short Spigot

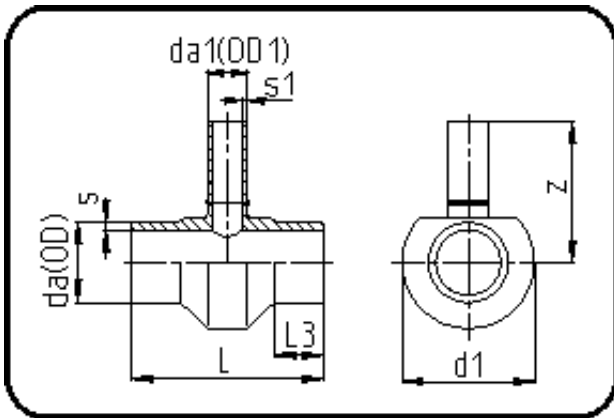

Code: 307

- Tee reduced
- short spigot
- machined
- **Butt-welding**
- **PE 100-RC black**

Dimension	Code	Detail	Weight
225/160	70.307.2216.09	225/160 SDR9 ISO S-4	10.90

	Unit	Nominale	Tol+	Tol-
da(OD)	mm	225	2.10	0.00
L	mm	310	3.00	3.00
L3	mm	50	1.50	1.50
s	mm	25,2	2.70	0.00
d1	mm	318	1.50	1.50
s1	mm	17,9	1.90	0.00
da(OD1)	mm	160	1.50	0.00
z	mm	238	18.00	18.00