

## Fittings with short Spigot

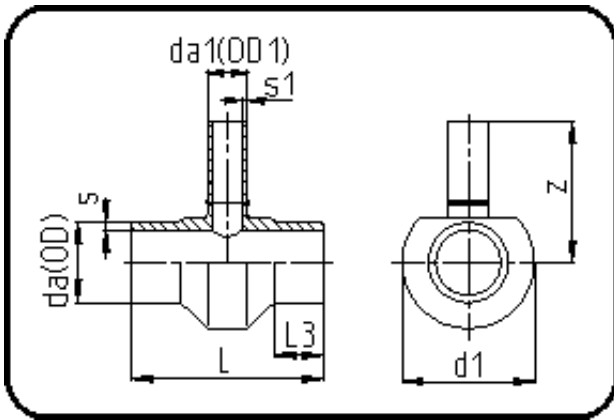

Code: 307

- Tee reduced
- short spigot
- machined
- **Butt-welding**
- PE 100-RC black

Dimension	Code	Detail	Weight
160/75	70.307.1675.09	160/75 SDR9 ISO S-4	5.20

	Unit	Nominale	Tol+	Tol-
da(OD)	mm	160	1.50	0.00
L	mm	225	2.00	2.00
L3	mm	50	1.00	1.00
s	mm	17,9	1.90	0.00
d1	mm	223	1.00	1.00
s1	mm	8,4	1.00	0.00
da(OD1)	mm	75	0.70	0.00
z	mm	205	3.00	3.00