

Fittings with short Spigot

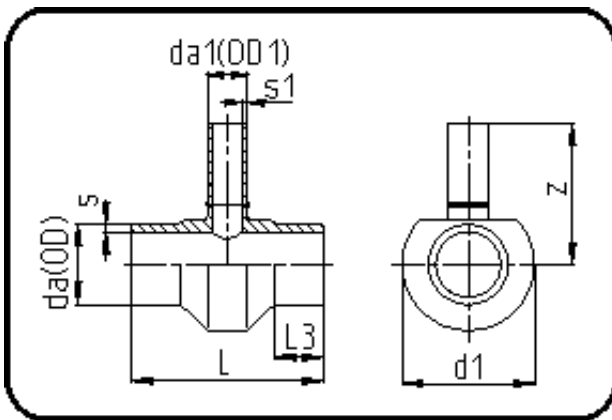

Code: 307

- Tee reduced
- short spigot
- machined
- **Butt-welding**
- PE 100-RC black

Dimension	Code	Detail	Weight
500/180	70.307.5018.09	500/180 SDR9 ISO S-4	44.50

	Unit	Nominale	Tol+	Tol-
da(OD)	mm	500	4.50	0.00
L	mm	410	4.50	4.50
L3	mm	90	1.50	1.50
s	mm	55,8	5.70	0.00
d1	mm	579	1.50	1.50
s1	mm	20,1	2.20	0.00
da(OD1)	mm	180	1.70	0.00
z	mm	425	18.00	18.00