

Sweep Bends

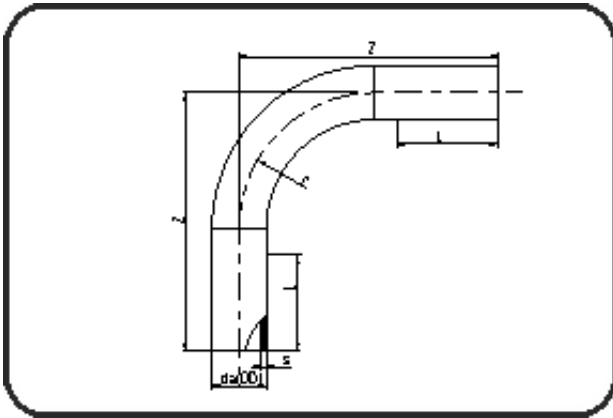

Code: 399

- Sweep Bend 90°
- radius 1.5 x OD
- formed out of pipe
- **Butt + E-socket-welding**
- **PE 100-RC black**

Dimension	Code	Detail	Weight
250	70.399.0250.11	250 SDR11 ISO S-5 16 bar	22.00

	Unit	Nominale	Tol+	Tol-
da(OD)	mm	250	0.00	0.00
L	mm	250	0.00	0.00
r	mm	375	0.00	0.00
s	mm	22,7	0.00	0.00
z	mm	780	75.00	75.00