

Sweep Bends

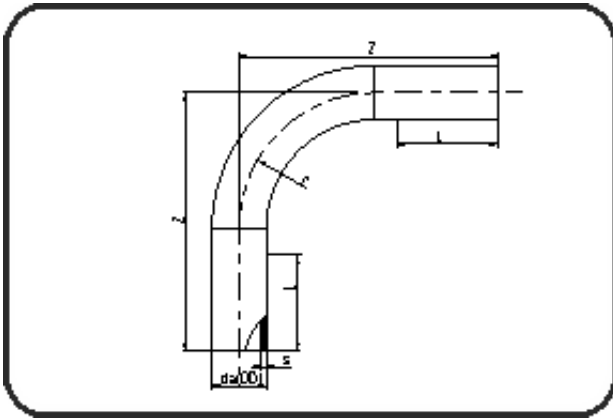

Code: 399

- Sweep Bend 90°
- radius 1.5 x OD
- formed out of pipe
- **Butt + E-socket-welding**
- **PE 100-RC black**

Dimension	Code	Detail	Weight
160	70.399.0160.11	160 SDR11 ISO S-5 16 bar	6.62

	Unit	Nominale	Tol+	Tol-
da(OD)	mm	160	0.00	0.00
L	mm	150	0.00	0.00
r	mm	240	0.00	0.00
s	mm	14,6	0.00	0.00
z	mm	550	75.00	75.00