

Fittings with short Spigot

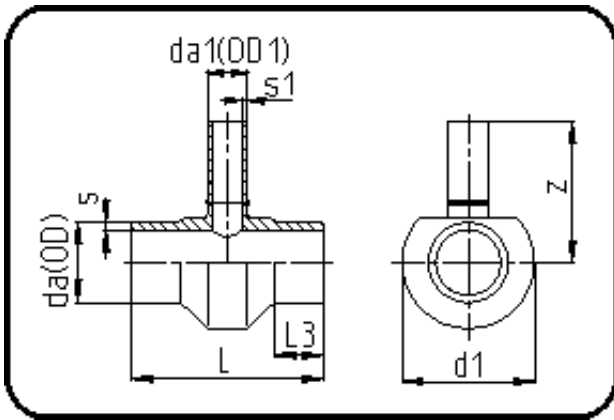

Code: 307

- Tee reduced
- short spigot
- machined
- **Butt-welding**
- PE 100-RC black

Dimension	Code	Detail	Weight
560/200	70.307.5620.09	560/200 SDR9 ISO S-4	60.00

	Unit	Nominale	Tol+	Tol-
da(OD)	mm	560	5.10	0.00
L	mm	550	2.00	2.00
L3	mm	150	1.00	1.00
s	mm	62,5	1.70	0.00
d1	mm	645	1.00	1.00
s1	mm	22,4	2.40	0.00
da(OD1)	mm	200	1.80	0.00
z	mm	455	15.00	15.00