

SURELINE II Pipes

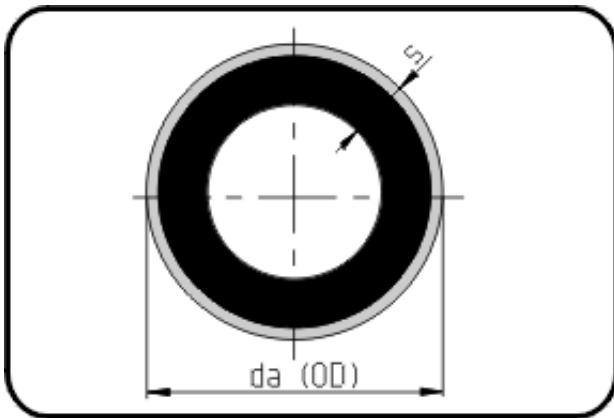

Code: 712.3

- Pipe black 12m
- with orange signal layer
- extruded
- PE 100-RC SURELINE II

Not available from stock - delivery time on request.

Dimension	Code	Detail	Weight
225	70.712.3225.17	225X13,4 SDR17 ISO S-8	9.03

	Unit	Nominale	Tol+	Tol-
da(OD)	mm	225	1.40	0.00
s	mm	13,4	1.50	0.00