

Fittings with short Spigot

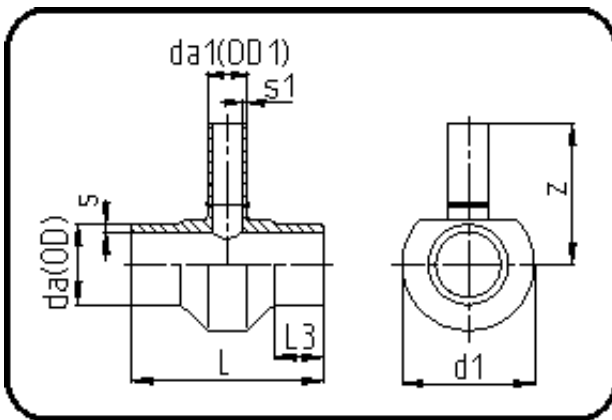

Code: 307

- Tee reduced
- short spigot
- machined
- **Butt-welding**
- **PE 100-RC black**

Dimension	Code	Detail	Weight
90/63	70.307.9063.09	90/63 SDR9 ISO S-4	1.50

	Unit	Nominale	Tol+	Tol-
da(OD)	mm	90	0.90	0.00
L	mm	213	3.00	3.00
L3	mm	50	1.50	1.50
s	mm	10,1	1.20	0.00
d1	mm	154	1.50	1.50
s1	mm	7,1	0.90	0.00
da(OD1)	mm	63	0.60	0.00
z	mm	170	15.00	15.00