

Fittings with short Spigot

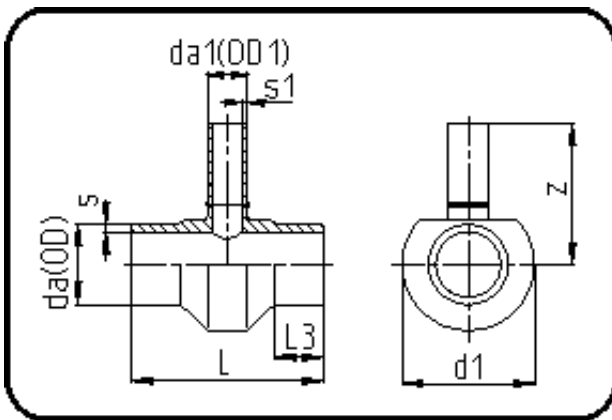

Code: 307

- Tee reduced
- short spigot
- machined
- **Butt-welding**
- PE 100-RC black

Dimension	Code	Detail	Weight
560/180	70.307.5618.09	560/180 SDR9 ISO S-4	52.00

	Unit	Nominale	Tol+	Tol-
da(OD)	mm	560	5.10	0.00
L	mm	530	2.00	2.00
L3	mm	150	1.00	1.00
s	mm	62,5	1.70	0.00
d1	mm	637	1.00	1.00
s1	mm	20,1	2.20	0.00
da(OD1)	mm	180	1.70	0.00
z	mm	455	15.00	15.00