

SURELINE II Pipes

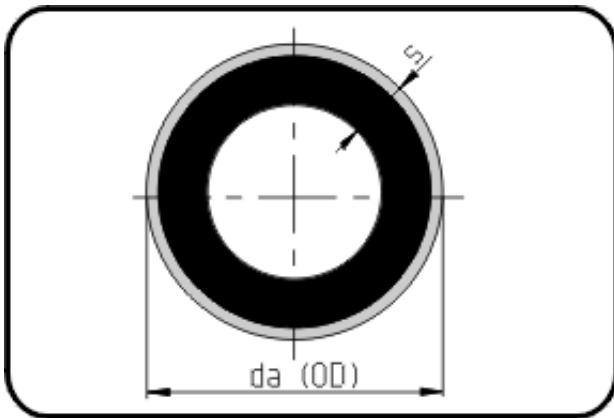

Code: 712.2

- Pipe black 12m
- with green signal layer
- extruded
- PE 100-RC SURELINE II

From dim. 250 not available from stock - delivery time on request.

Dimension	Code	Detail	Weight
500	70.712.2500.11	500X45,4 SDR11 ISO S-5	65.20

	Unit	Nominale	Tol+	Tol-
da(OD)	mm	500	0.00	0.00
s	mm	45,4	0.00	0.00