

Fittings with short Spigot

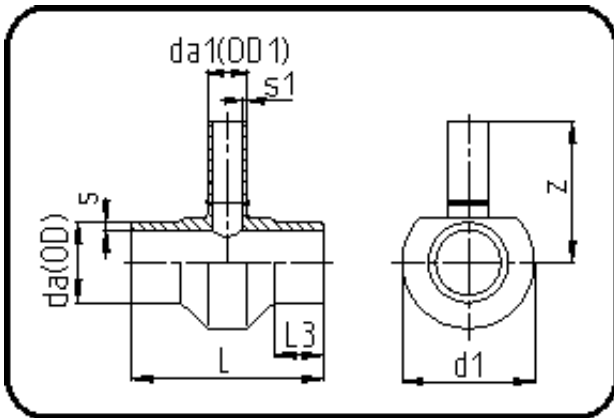

Code: 307

- Tee reduced
- short spigot
- machined
- **Butt-welding**
- PE 100-RC black

Dimension	Code	Detail	Weight
450/63	70.307.4563.09	450/63 SDR9 ISO S-4	40.50

	Unit	Nominale	Tol+	Tol-
da(OD)	mm	450	4.10	0.00
L	mm	263	4.50	4.50
L3	mm	75	1.50	1.50
s	mm	50,3	5.20	0.00
d1	mm	504	1.50	1.50
s1	mm	7,1	0.90	0.00
da(OD1)	mm	63	0.60	0.00
z	mm	350	15.00	15.00