

## Fittings with short Spigot

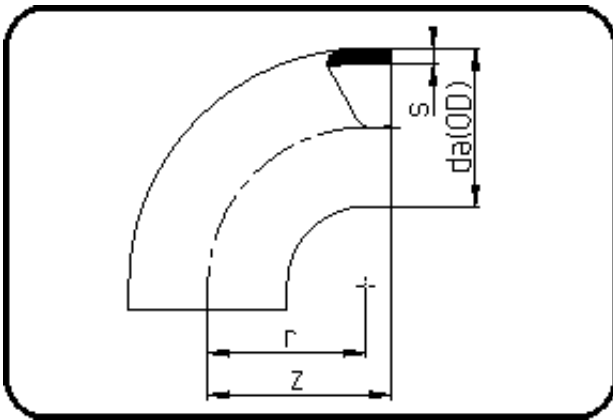

Code: 001

- Bend 90°
- short spigot
- injection moulded
- **Butt-welding**
- PE 100-RC black

Dimension	Code	Detail	Weight
125	70.001.0125.11	125X11,4 SDR11 ISO S-5	0.91

	Unit	Nominale	Tol+	Tol-
da(OD)	mm	125	1.20	0.00
r	mm	125	0.00	0.00
s	mm	11,4	1.30	0.00
z	mm	140	4.50	4.50