

Fittings with short Spigot

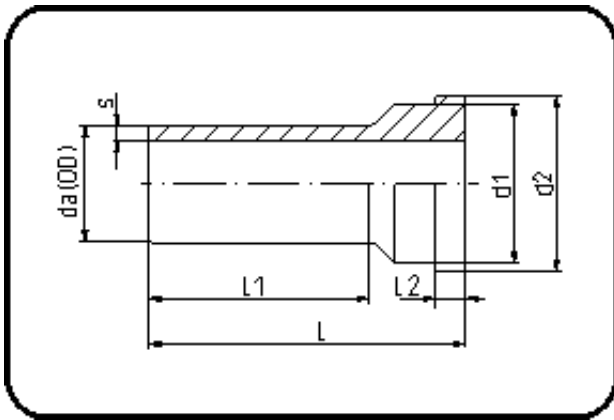

Code: 024.2

- Union end
- spare part Union 024
- injection moulded
- **Butt-welding**
- **PE 100-RC black**

Dimension	Code	Detail	Weight
40	70.024.2040.11	40X3,7 SDR11 ISO S-5	0.05

	Unit	Nominale	Tol+	Tol-
da(OD)	mm	40	0.40	0.00
L	mm	65	1.50	1.50
L1	mm	42	1.50	1.50
L2	mm	6	0.60	0.00
s	mm	3,7	0.00	0.00
d1	mm	52,6	0.00	0.30
d2	mm	56,3	0.00	0.30