

Fittings with short Spigot

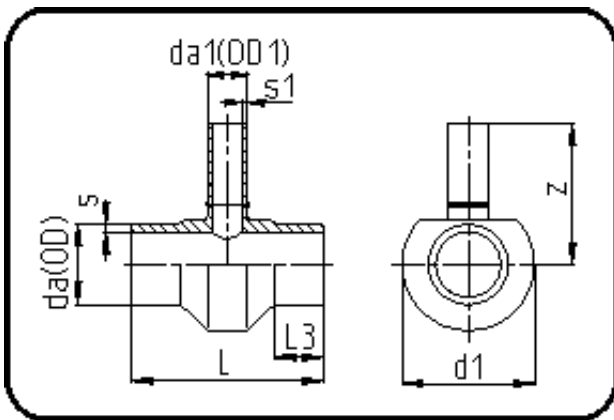

Code: 307

- Tee reduced
- short spigot
- machined
- **Butt-welding**
- PE 100-RC black

Dimension	Code	Detail	Weight
315/63	70.307.3163.09	315/63 SDR9 ISO S-4	22.00

	Unit	Nominale	Tol+	Tol-
da(OD)	mm	315	2.90	0.00
L	mm	213	3.00	3.00
L3	mm	50	1.50	1.50
s	mm	35,2	3.70	0.00
d1	mm	371	1.50	1.50
s1	mm	7,1	0.90	0.00
da(OD1)	mm	63	0.60	0.00
z	mm	282,5	15.00	15.00