

Segmented Fittings

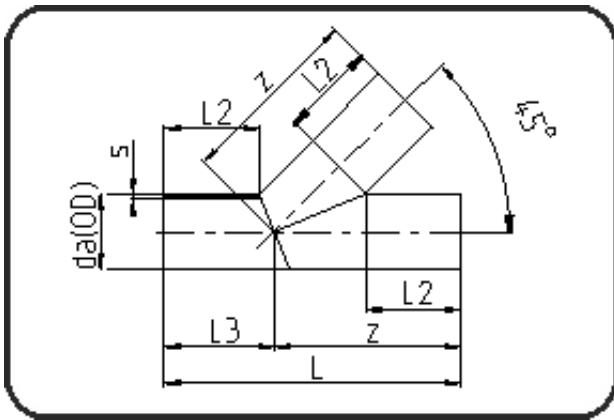

Code: 325

- Tee 45°
- segmented
- derating factor 0.6
- **Butt + E-socket-welding**
- **PE 100-RC black**

Dimension	Code	Detail	Weight
500	70.325.0500.11	500X45,4 SDR11 ISO S-5	154.00

	Unit	Nominale	Tol+	Tol-
da(OD)	mm	500	0.00	0.00
L	mm	1.408	30.00	30.00
L3	mm	454	0.00	0.00
L2	mm	350	0.00	0.00
s	mm	45,4	0.00	0.00
z	mm	954	30.00	30.00