

SURELINE II Pipes

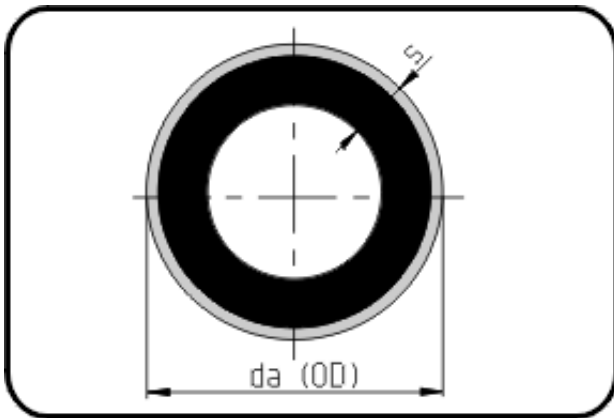

Code: 712.2

- Pipe black 12m
- with green signal layer
- extruded
- **PE 100-RC SURELINE II**

From dim. 250 not available from stock - delivery time on request.

Dimension	Code	Detail	Weight
180	70.712.2180.17	180X10,7 SDR17 ISO S-8	5.77

	Unit	Nominale	Tol+	Tol-
da(OD)	mm	180	1.10	0.00
s	mm	10,7	1.20	0.00