

Fittings with short Spigot

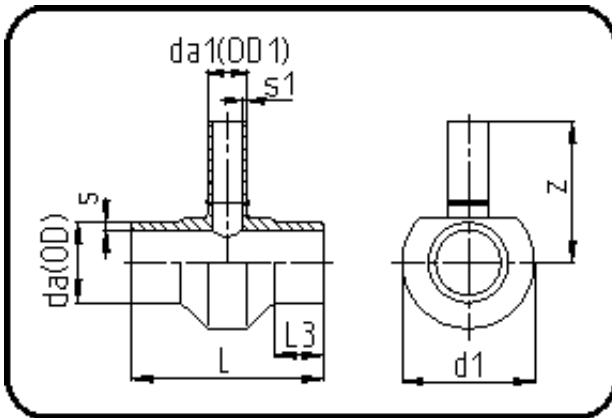

Code: 307

- Tee reduced
- short spigot
- machined
- **Butt-welding**
- **PE 100-RC black**

Dimension	Code	Detail	Weight
450/180	70.307.4518.09	450/180 SDR9 ISO S-4	42.70

	Unit	Nominale	Tol+	Tol-
da(OD)	mm	450	4.10	0.00
L	mm	380	4.50	4.50
L3	mm	75	1.50	1.50
s	mm	50,3	5.20	0.00
d1	mm	532	1.50	1.50
s1	mm	20,1	2.20	0.00
da(OD1)	mm	180	1.70	0.00
z	mm	400	18.00	18.00