

Fittings with short Spigot

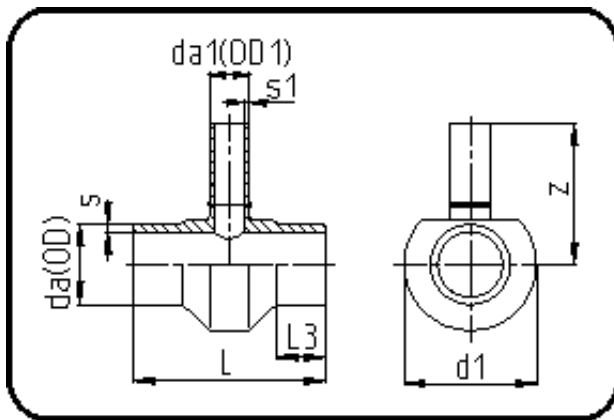

Code: 307

- Tee reduced
- short spigot
- machined
- **Butt-welding**
- PE 100-RC black

Dimension	Code	Detail	Weight
400/90	70.307.4090.07	400/90 SDR7,4 ISO S-3,2	42.60

	Unit	Nominale	Tol+	Tol-
da(OD)	mm	400	3.60	0.00
L	mm	290	4.50	4.50
L3	mm	75	1.50	1.50
s	mm	54,7	5.60	0.00
d1	mm	459	1.50	1.50
s1	mm	12,3	1.40	0.00
da(OD1)	mm	90	0.90	0.00
z	mm	325	15.00	15.00