

Fittings with short Spigot

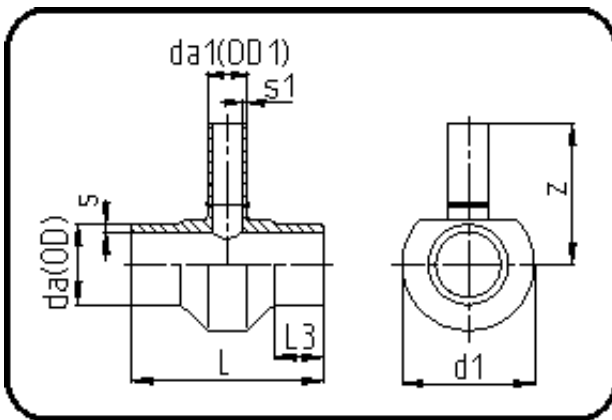

Code: 307

- Tee reduced
- short spigot
- machined
- **Butt-welding**
- **PE 100-RC black**

Dimension	Code	Detail	Weight
500/75	70.307.5075.09	500/75 SDR9 ISO S-4	41.00

	Unit	Nominale	Tol+	Tol-
da(OD)	mm	500	4.50	0.00
L	mm	305	3.00	3.00
L3	mm	75	1.00	1.00
s	mm	55,8	5.70	0.00
d1	mm	556	1.00	1.00
s1	mm	8,4	1.00	0.00
da(OD1)	mm	75	0.70	0.00
z	mm	375	3.00	3.00