

Fittings with short Spigot

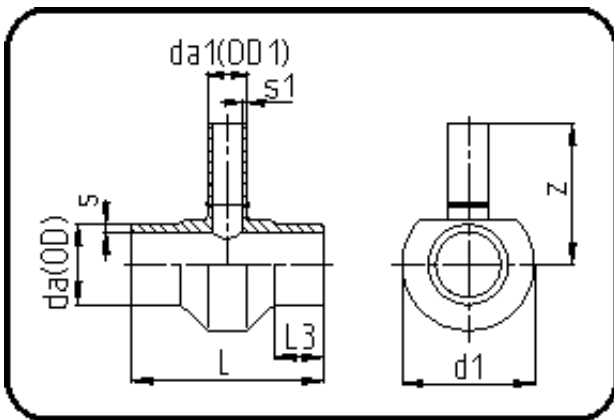

Code: 307

- Tee reduced
- short spigot
- machined
- **Butt-welding**
- **PE 100-RC black**

Dimension	Code	Detail	Weight
250/180	70.307.2518.09	250/180 SDR9 ISO S-4	20.00

	Unit	Nominale	Tol+	Tol-
da(OD)	mm	250	2.30	0.00
L	mm	330	3.00	3.00
L3	mm	50	1.50	1.50
s	mm	27,9	2.90	0.00
d1	mm	350	1.50	1.50
s1	mm	20,1	2.20	0.00
da(OD1)	mm	180	1.70	0.00
z	mm	300	18.00	18.00