

SURELINE II Pipes

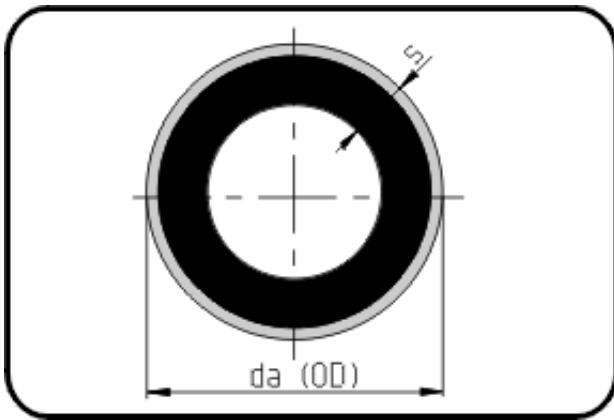

Code: 712.2

- Pipe black 12m
- with green signal layer
- extruded
- PE 100-RC SURELINE II

From dim. 250 not available from stock - delivery time on request.

Dimension	Code	Detail	Weight
250	70.712.2250.11	250X22,7 SDR11 ISO S-5	16.30

	Unit	Nominale	Tol+	Tol-
da(OD)	mm	250	1.50	0.00
s	mm	22,7	2.40	0.00