

Segmented Fittings

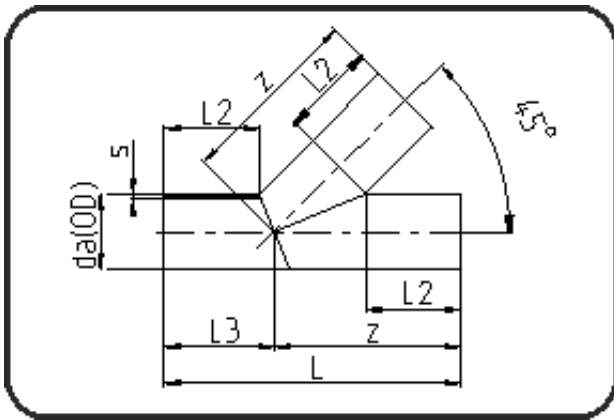

Code: 325

- Tee 45°
- segmented
- derating factor 0.6
- **Butt + E-socket-welding**
- **PE 100-RC black**

Dimension	Code	Detail	Weight
315	70.325.0315.11	315X28,6 SDR11 ISO S-5	48.60

	Unit	Nominale	Tol+	Tol-
da(OD)	mm	315	0.00	0.00
L	mm	1.145	30.00	30.00
L3	mm	415	0.00	0.00
L2	mm	350	0.00	0.00
s	mm	28,6	0.00	0.00
z	mm	730	30.00	30.00