

## SURELINE II Pipes

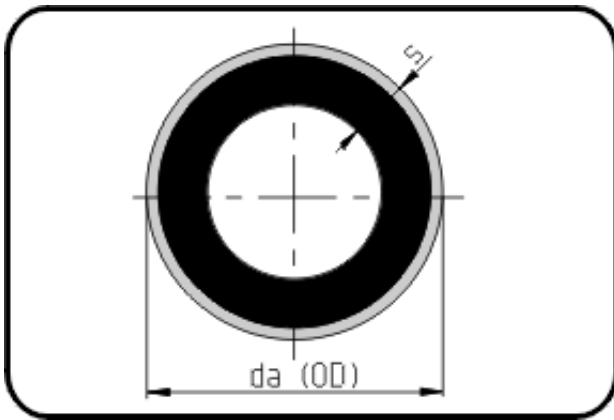

Code: 712.2

- Pipe black 12m
- with green signal layer
- extruded
- PE 100-RC SURELINE II

From dim. 250 not available from stock - delivery time on request.

Dimension	Code	Detail	Weight
160	70.712.2160.11	160X14,6 SDR11 ISO S-5	6.74

	Unit	Nominale	Tol+	Tol-
da(OD)	mm	160	1.00	0.00
s	mm	14,6	1.60	0.00